



# LISTINO PREZZI

## Manufatti in C.L.S.

Vasche IMHOFF | Degrassatori  
Serbatoi | Pozzetti di cacciata

**60**  
ANNI COSTRUITI  
CON PASSIONE  
 **f.lli anelli**  
1960  2020

01 APRILE 2021

[www.fratellianelli.com](http://www.fratellianelli.com) |   





1 aprile 2021

Pozzetto con sifone di  
CACCIATA

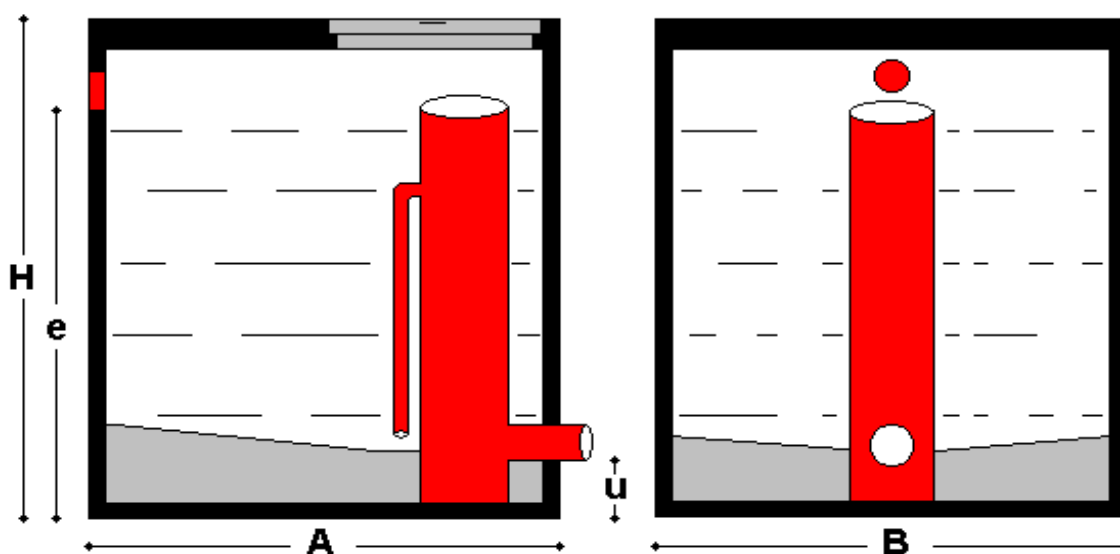

COD.ARTICOLO 01379

A	B	H	e	u	Tubo	Peso kg	Prezzo €
cm	cm	cm	cm	cm	∅		
100	100	106	77	20	125	1050 + 320	565,00
		98+8					

1 aprile 2021

# SEPARATORE STATICO Olio e Grasso

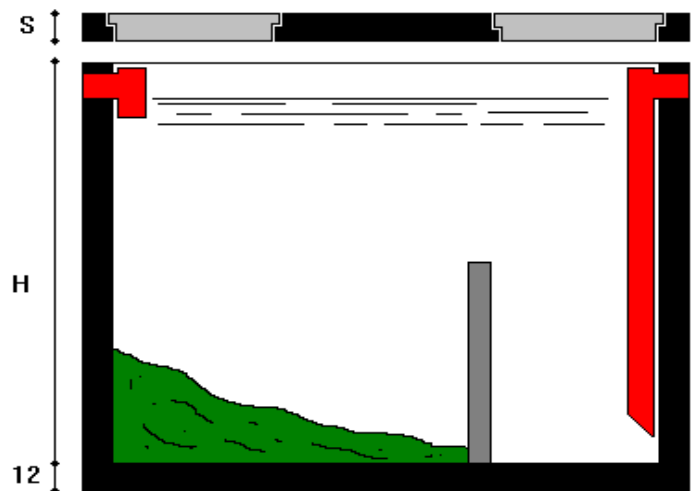
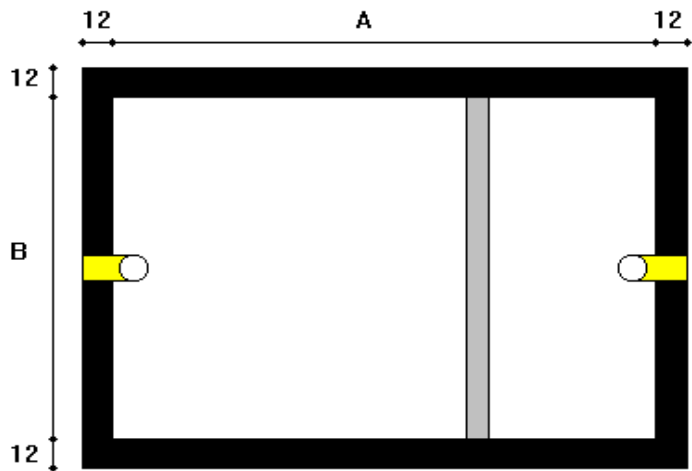

## Relazione tecnica

Il manufatto deve essere riempito di acqua, in modo che il liquame in arrivo si separi per differenza di peso specifico.

- Le parti pesanti si depositano sul fondo della prima camera separata dalla lastrina.
- Le parti leggere (olio e grasso) rimangono in sospensione sopra l'acqua.
- I tubi in uscita pesca in basso nella seconda camera e trasporta liquido separato dalle parti leggere e pesanti

Litri UTILI	A cm	B cm	H cm	S cm	Peso kg	Utenti numero	Prezzo €
1.110	100	100	130	15/20	1900 + 570	15	610,00
ART. 01397							
1.650	150	100	130	15/20	2500 + 880	20/30	885,00
ART. 013971							
2.200	200	100	130	15/20	3100 + 1170	35/40	980,00
ART. 013972							

1 aprile 2021

# DEOLIATORE GARAGE

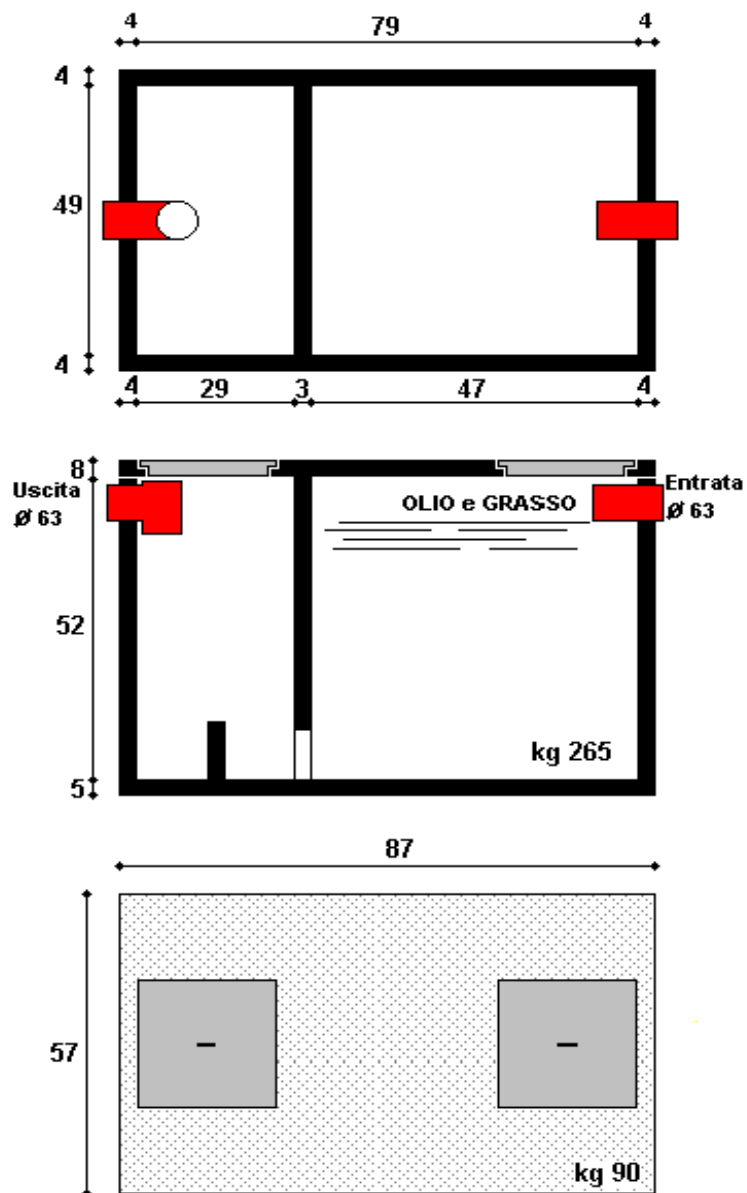

**Litri 160**

**Cad. € 155,00**

ART. 01378

1 aprile 2021

## DEGRASSATORE STATICO olio e grasso

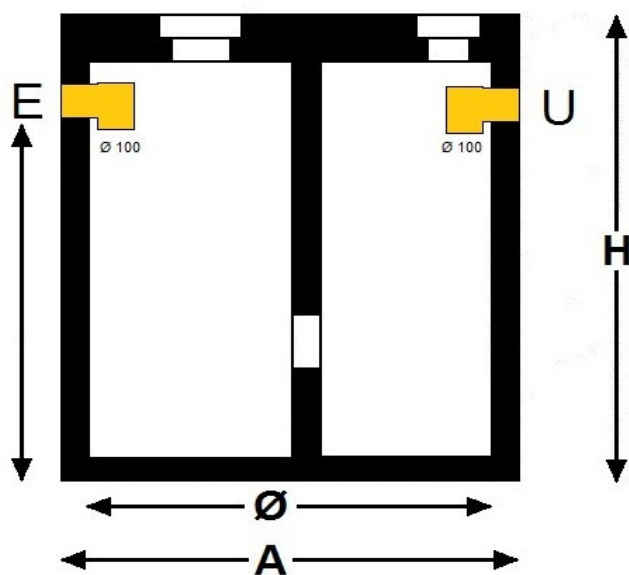

**SEZIONE VERTICALE**

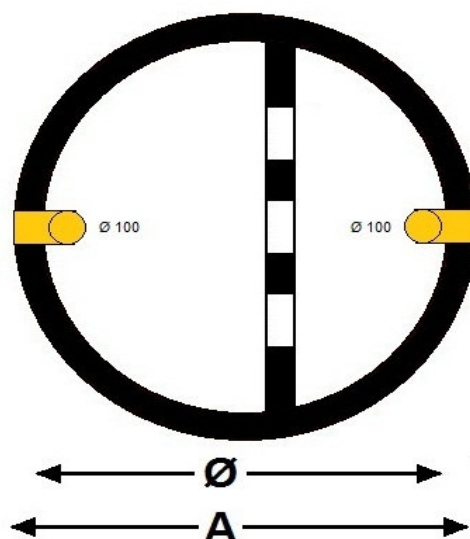

**SEZIONE ORIZZONTALE**

Codice	Litri	Utenti	Ø cm	A cm	H cm	Spessore Chiusino	Spessore Vasca	Tappi n° 2	E cm	Peso Kg	Prezzo €
013781	320	6	80	90	101	8	5	Ø 23	80	600	230,00
013782	520	10	100	110	101	8	5	23x23	80	800	345,00

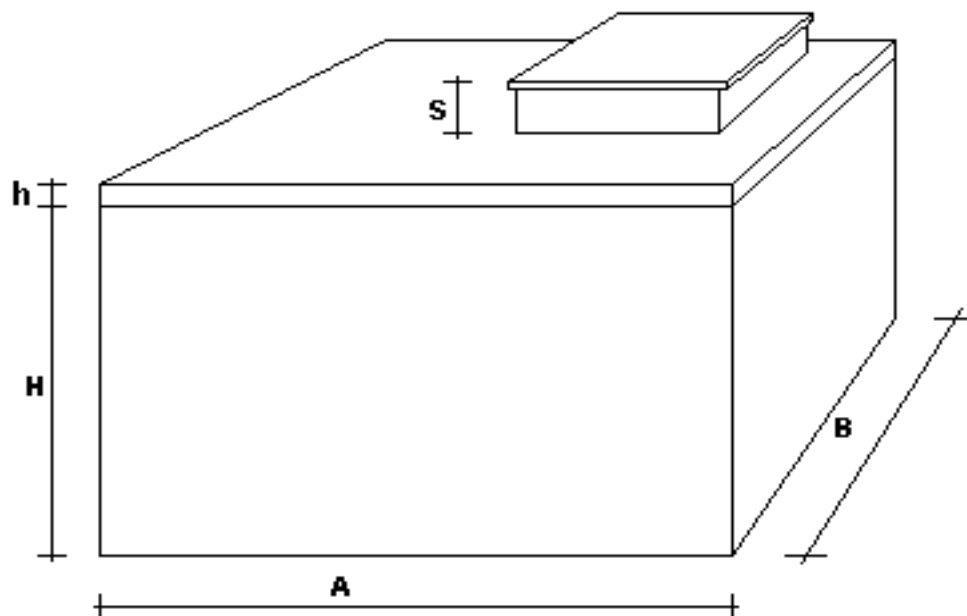

Misure esterne serbatoi						Peso kg		COMPLETA €/cad.	Trasporto e Scarico	solo LASTRA
A cm	B cm	H cm	h cm	S cm	VOLUME mc	Vasca	Lastra			
136	136	156	8	8	2,00	1.750	340	721,00	160,00	90,00
ART. 01394										
186	136	162	8/12	8	3,00	2.380	720	875,00	160,00	136,50
ART. 01395										
216	170	169	12	8	4,70	3.060	1.040	1.340,00	200,00	200,00
ART. 013951										
216	170	210	12	8	6,00	3.610	1.040	1.650,00	200,00	200,00
ART. 013952										