



# f.lli anelli

[www.fratellianelli.com](http://www.fratellianelli.com)

Email: [anelli@fratellianelli.com](mailto:anelli@fratellianelli.com)

Materiali da costruzione - Manufatti in cemento - Isolanti Termici - Acustici - Impermeabilizzazioni - Controsoffitti - Pavimenti - Rivestimenti - Idrosanitari - Arredo Bagno - Caminetti

**Vasche IMHOFF  
DEGRASSATORI  
SERBATOI -CACCIATA**

**01 Settembre 2015**

**LISTINO PREZZI**

**Manufatti**

**in C.L.S.**



**f.lli anelli snc**

Sede Legale e Operativa:  
47828 S.ERMETE di Santarcangelo (RN)  
Via Marecchiese 1068  
Telefono 0541 750155 - Fax 0541 758454



**1 ottobre 2017**

- 1 Entrata
- 2 Uscita
- 3 Sedimentazione
- 4 Digestione
- 5 Uscita gas
- 6 Tubo estrazione

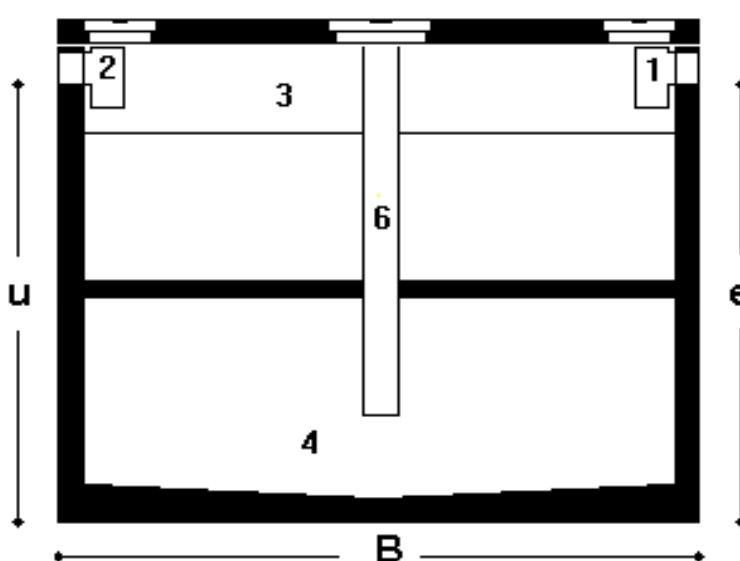
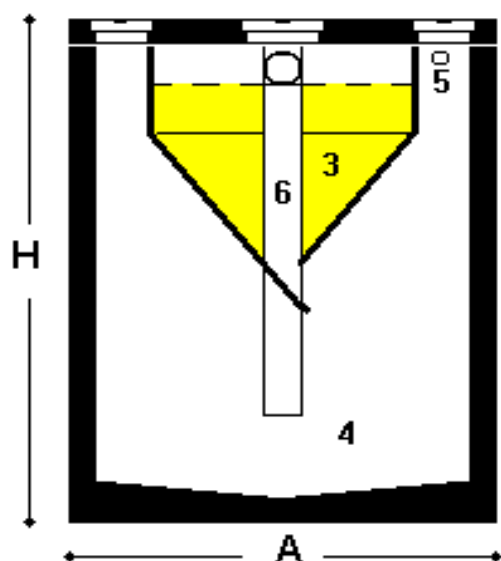
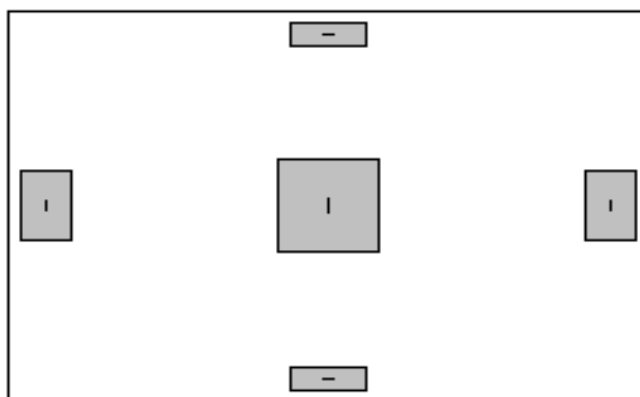

Tipo	UTENTI		Sedim. litri	Digest. litri	A cm	B cm	H cm	e cm	u cm	Tubo Ø	Vasca Kg	Lastra	Kg	Prezzo	Trasporto
	Scarico fognat.	Scarico dispers.										per auto		€	e scarico
01	9	7	400	1500	136	136	156+ 8	138	136	125	1960	136x136x 8	340	690,00	160,00
02	14	11	600	2210	136	186	162+12	143	141	125	2720	136x186x12	720	790,00	160,00
03	20	16	815	3520	170	215	169+12	149	147	160	3540	170x215x12	1040	1.020,00	160,00
04	28	22	1250	4400	170	215	210+12	190	188	160	4150	170x215x12	1040	1.210,00	200,00

Tipo	Scarico fognat.	Scarico dispers.	Sedim. litri	Digest. litri	A cm	B cm	H cm	e cm	u cm	Tubo Ø	Vasca Kg	CARRABILE	Kg	Prezzo	Trasporto
												1 foro 40x40		€	e scarico
01-C	9	7	400	1500	136	136	156+20	138	136	125	1960	144x144x20	800	790,00	160,00
02-C	14	11	600	2210	136	186	162+20	143	141	125	2720	145x200x20	1190	920,00	160,00
03-C	20	16	815	3520	170	215	169+20	149	147	160	3540	180x220x20	1730	1.160,00	160,00
04-C	28	22	1250	4400	170	215	210+20	190	188	160	4150	180x220x20	1730	1.370,00	200,00

1 ottobre 2017

- 1 Entrata
- 2 Uscita
- 3 Sedimentazione
- 4 Digestione
- 5 Uscita gas
- 6 Tubo estrazione

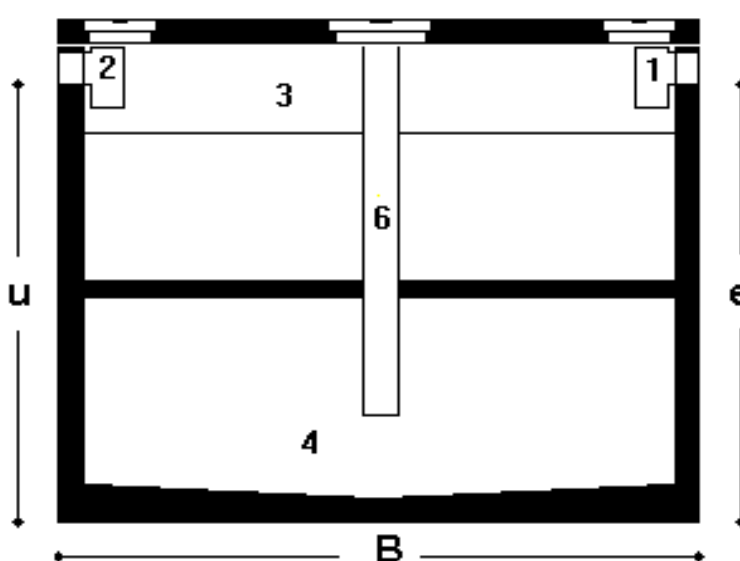
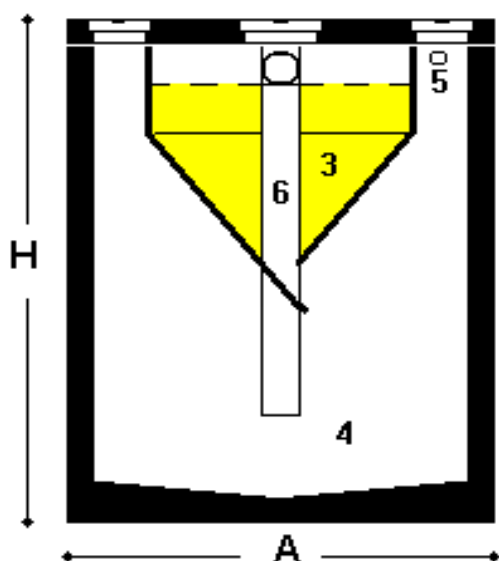
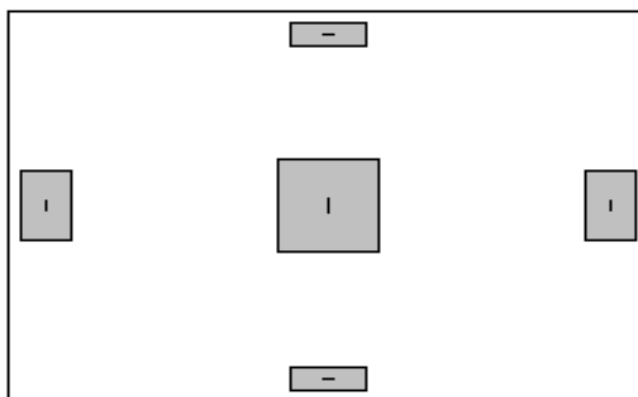

Tipo	UTENTI	Sedim. litri	Digest. litri	A cm	B cm	H cm	e cm	u cm	Tubo Ø	Vasca Kg	Lastra	Prezzo €	Trasporto e scarico	
											per auto			Kg
01	7	400	1500	136	136	156+ 8	138	136	125	1960	136x136x 8	340	690,00	160,00
02	11	600	2210	136	186	162+12	143	141	125	2720	136x186x12	720	790,00	160,00
03	16	815	3520	170	215	169+12	149	147	160	3540	170x215x12	1040	1.020,00	160,00
04	22	1250	4400	170	215	210+12	190	188	160	4150	170x215x12	1040	1.210,00	200,00

Tipo	UTENTI	Sedim. litri	Digest. litri	A cm	B cm	H cm	e cm	u cm	Tubo Ø	Vasca Kg	CARRABILE		Prezzo €	Trasporto e scarico
											1 foro 40x40	Kg		
											2 fori 30x30			
01-C	7	400	1500	136	136	156+20	138	136	125	1960	144x144x20	800	790,00	160,00
02-C	11	600	2210	136	186	162+20	143	141	125	2720	145x200x20	1190	920,00	160,00
03-C	16	815	3520	170	215	169+20	149	147	160	3540	180x220x20	1730	1.160,00	160,00
04-C	22	1250	4400	170	215	210+20	190	188	160	4150	180x220x20	1730	1.370,00	200,00

1 aprile 2013

## Pozzetto con sifone di CACCIATA

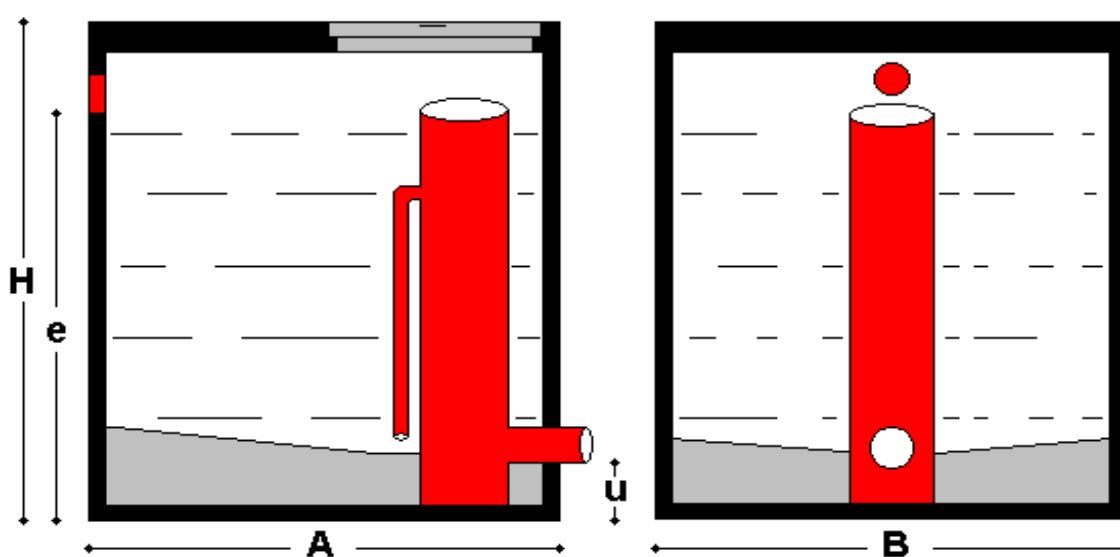

A	B	H	e	u	Tubo	Peso kg	Prezzo €
cm	cm	cm	cm	cm	Ø		
100	100	105	77	20	125	1050 + 320	<b>550,00</b>

# SEPARATORE STATICO Olio e Grasso

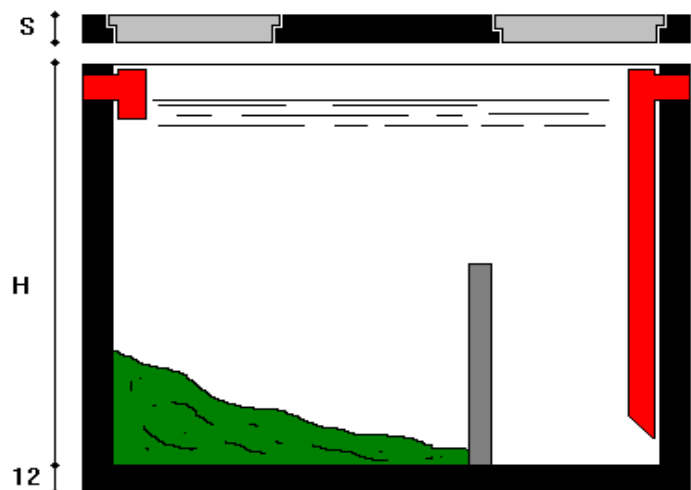
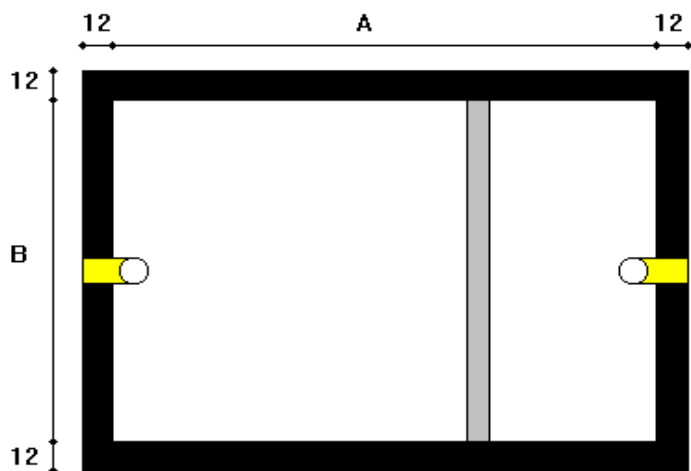

## Relazione tecnica

Il manufatto deve essere riempito di acqua, in modo che il liquame in arrivo si separi per differenza di peso specifico.

- Le parti pesanti si depositano sul fondo della prima camera separata dalla lastrina.
- Le parti leggere (olio e grasso) rimangono in sospensione sopra l'acqua.
- Il tubo in uscita pesca in basso nella seconda camera e trasporta liquido separato dalle parti leggere e pesanti

Litri UTILI	A cm	B cm	H cm	S cm	Peso kg	Utenti numero	Prezzo €
<b>1.110</b>	100	100	130	15/20	1900 + 570	<b>15</b>	<b>590,00</b>
<b>1.650</b>	150	100	130	15/20	2500 + 880	<b>20/30</b>	<b>860,00</b>
<b>2.200</b>	200	100	130	15/20	3100 + 1170	<b>35/40</b>	<b>950,00</b>

1 aprile 2013

# DEOLIATORE GARAGE

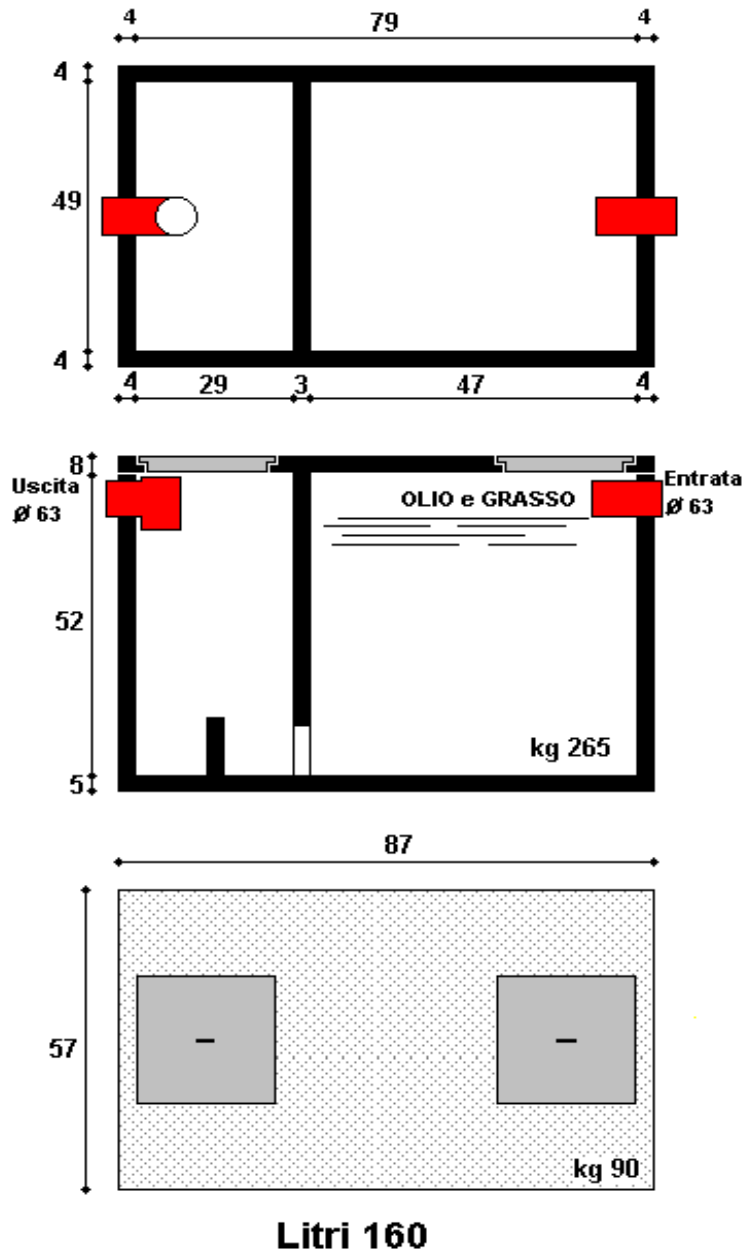

**Cad. € 150,00**

# DEGRASSATORE STATICO olio e grasso

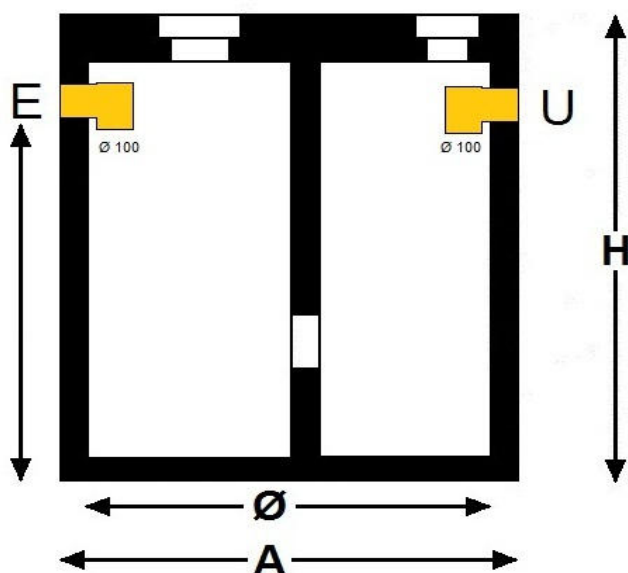
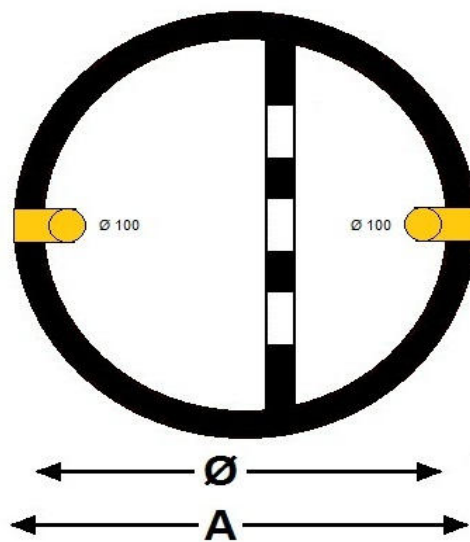
**SEZIONE VERTICALE**

**SEZIONE ORIZZONTALE**

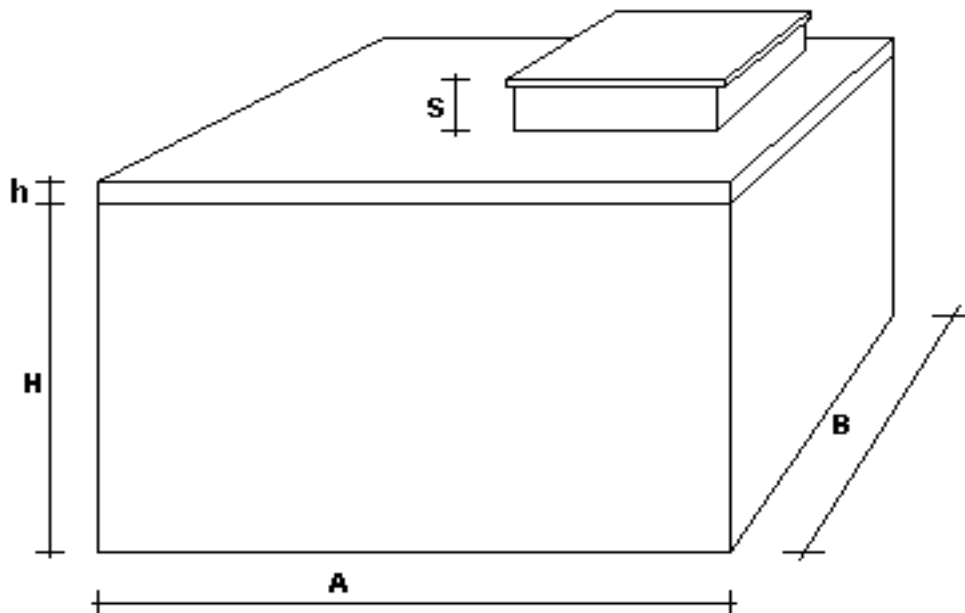
Codice	Litri	Utenti	Ø cm	A cm	H cm	Spessore Chiusino	Spessore Vasca	Tappi n° 2	E cm	Peso Kg	Prezzo €
013781	<b>320</b>	<b>6</b>	80	90	101	8	5	Ø 23	80	600	<b>220,00</b>
013782	<b>520</b>	<b>10</b>	100	110	101	8	5	23x23	80	800	<b>335,00</b>

**1 aprile 2013**

Misure esterne serbatoi						Peso kg		COMPLETA €/cad.	Trasporto e Scarico	solo LASTRA
A cm	B cm	H cm	h cm	S cm	VOLUME mc	Vasca	Lastra			
136	136	156	8	8	<b>2,00</b>	1.750	340	<b>700,00</b>	<b>160,00</b>	85,00
186	136	162	8/12	8	<b>3,00</b>	2.380	720	<b>850,00</b>	<b>160,00</b>	130,00
216	170	169	12	8	<b>4,70</b>	3.060	1.040	<b>1.300,00</b>	<b>200,00</b>	190,00
216	170	210	12	8	<b>6,00</b>	3.610	1.040	<b>1.600,00</b>	<b>200,00</b>	190,00